

# Fast Track Switching Automation IT für die Anforderungen der Automatisierung

HARTING AG  
Dominik Thür

# Automation IT

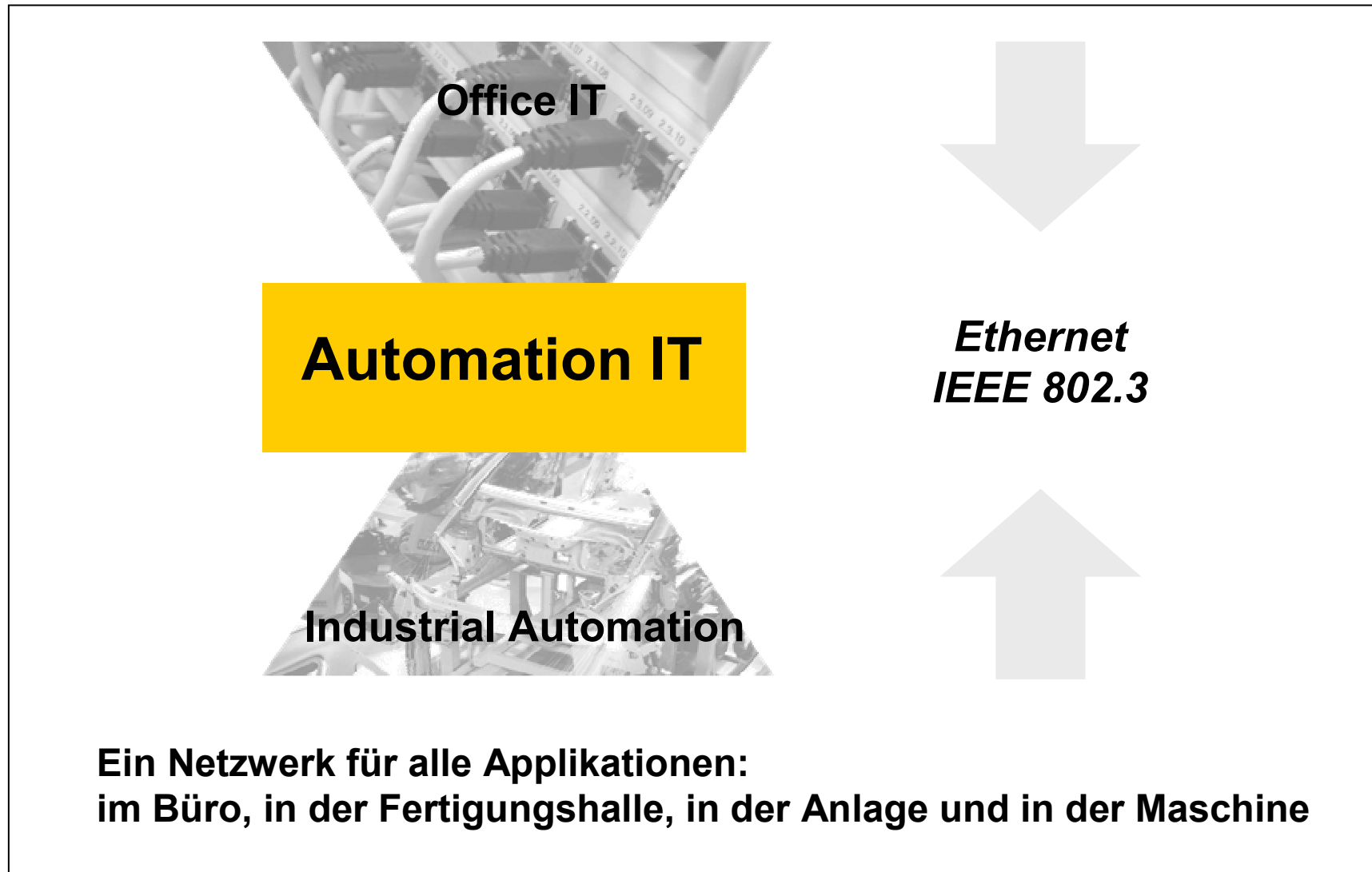

# Situation in der Industrieautomation heute:

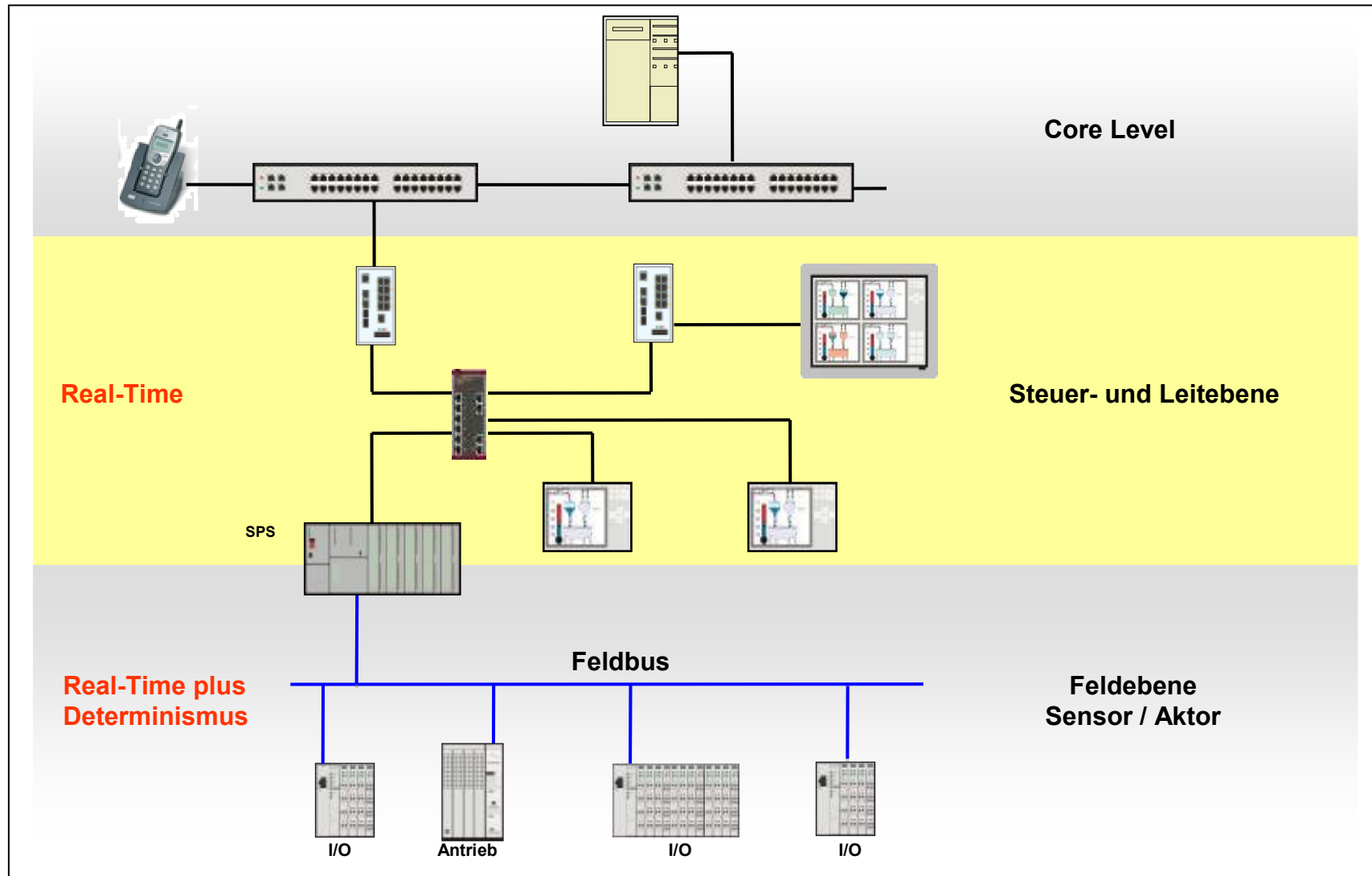

# Substitution in der Feldebene

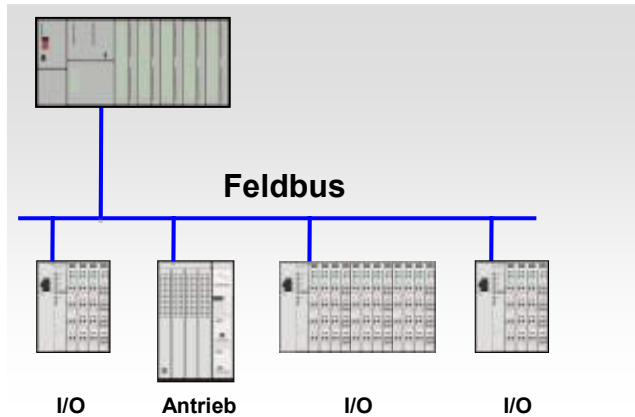

Feldebene  
Sensor / Aktor

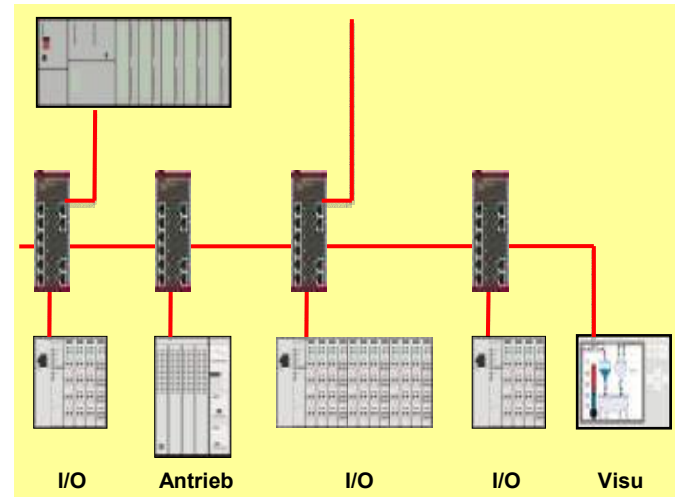

- PROFIBUS
- INTERBUS
- DeviceNet
- ...

- Industrial Ethernet

# Ethernet in den Systemebenen

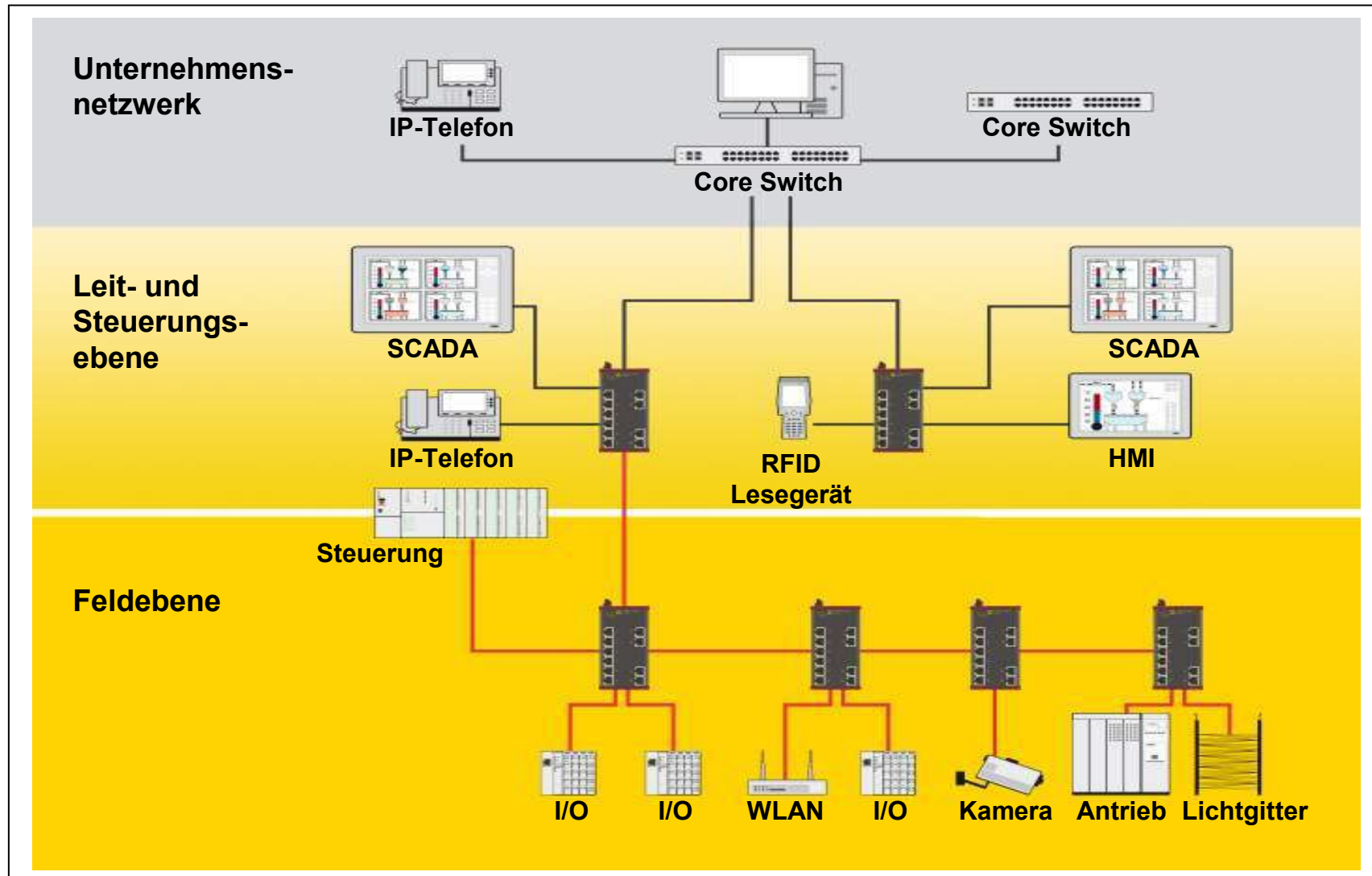

## Standard unchanged Ethernet in der Feldebene

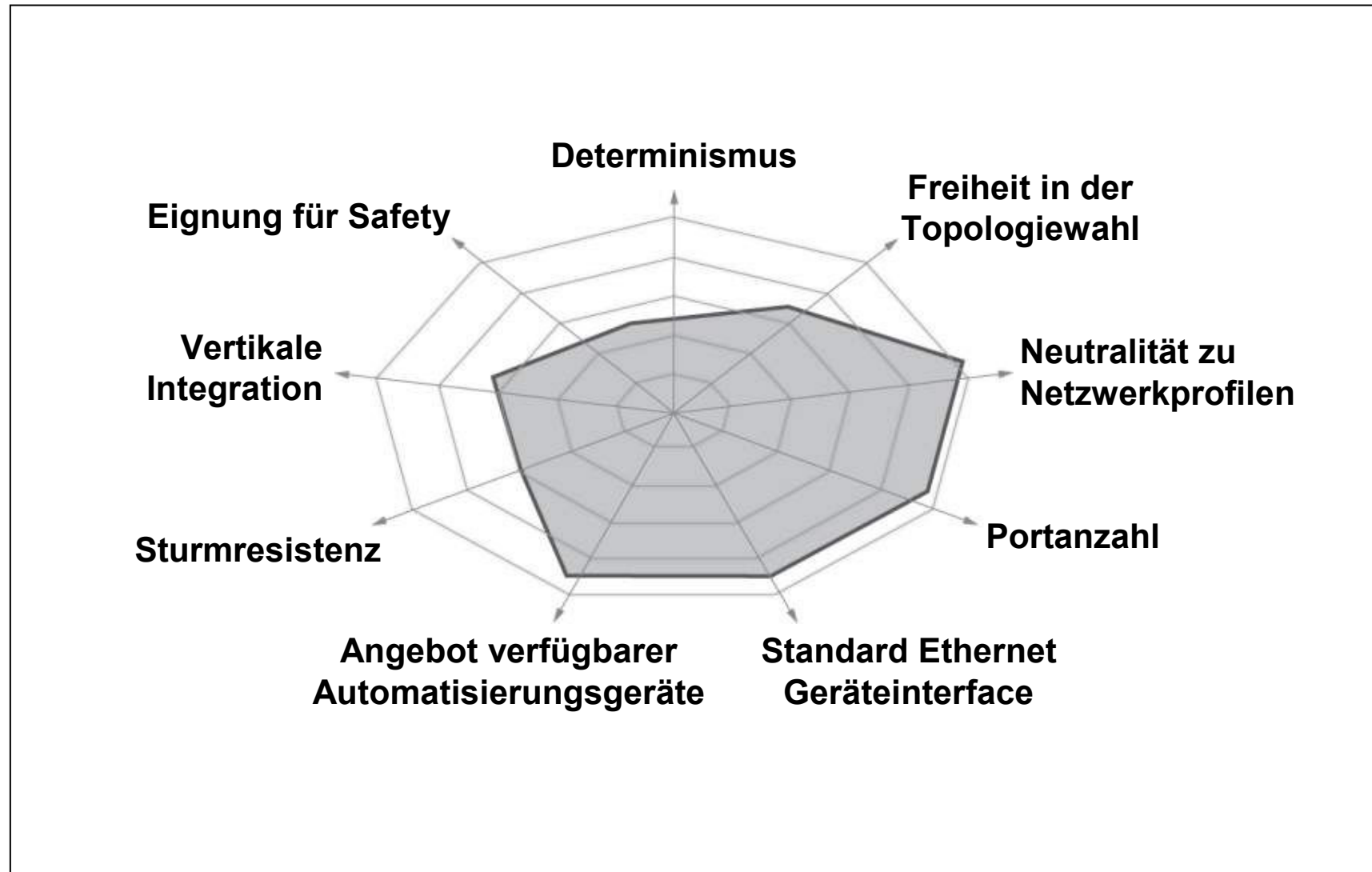

## Changed Ethernet in der Feldebene

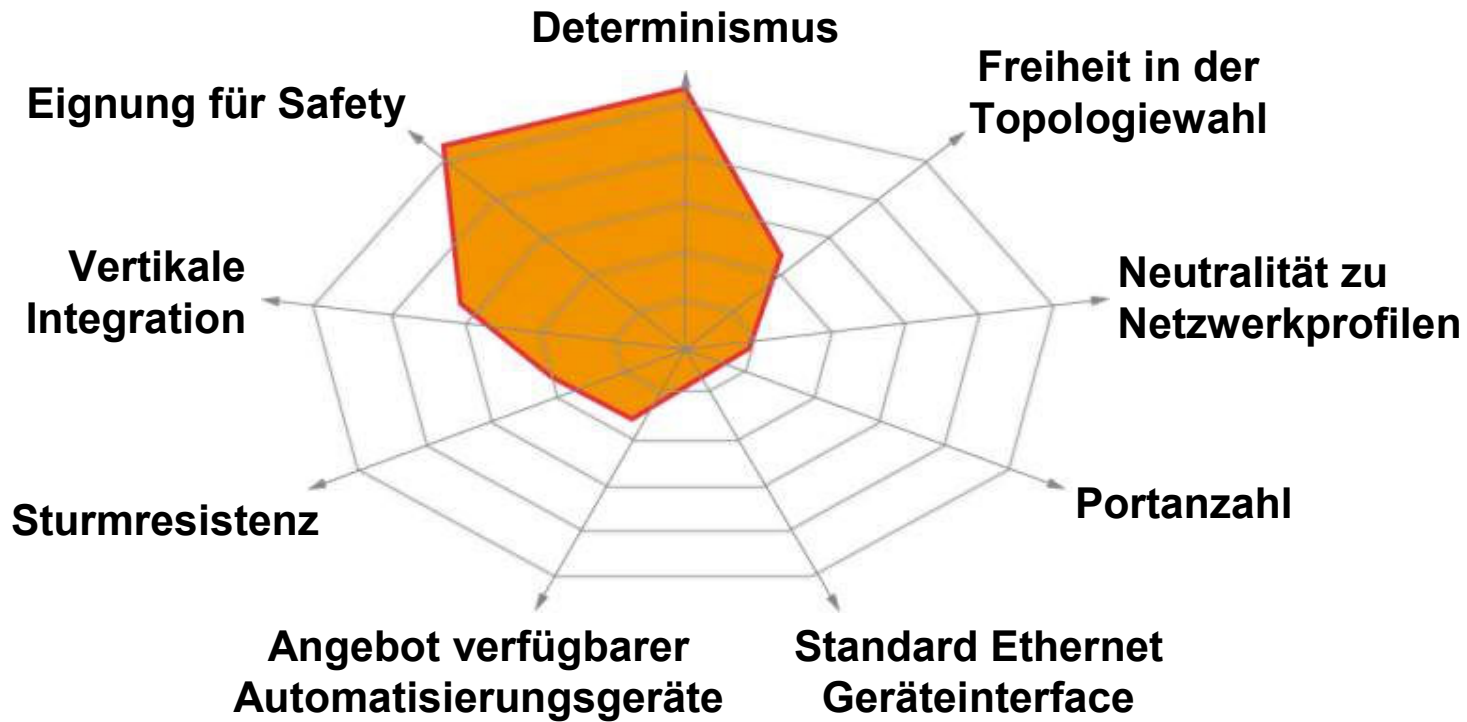

- Das Systemnetzwerk garantiert den Determinismus
- Jeder Teilnehmer im Netz braucht spezielle Hardware

## Standard Ethernet Performance (IEEE 802.3)

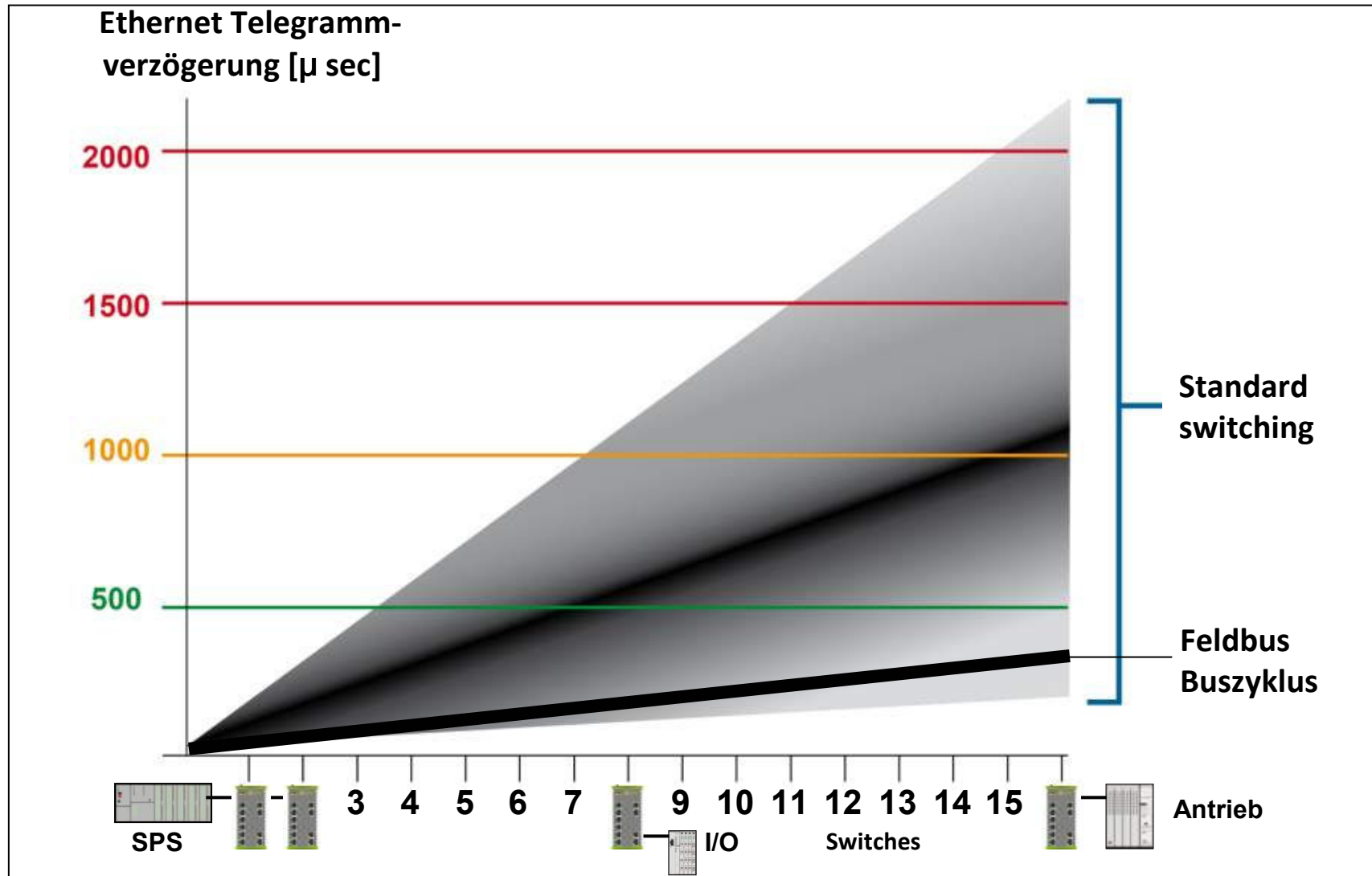

# Ethernet IEEE 802.1q: Vorfahrtsregeln, die nicht weiterhelfen

Preamble	SFD	Destination	Source	VLAN		Type	Data	FCS
7 Byte	1	6 Byte	6 Byte	8100	xx	8892		4 Byte

## Ethernet Header

Priorisierung eines Automatisierungsprotokolls



Priority	Type
7	Network critical
6	Voice
6	Automation
5	Video
4	Business critical
0-3	Datatransfer
0-3	Web
0-3	TCP acknowledge



**Automatisierungsprotokolle und IT-Protokolle konkurrieren.**

## Stau trotz Nachrichtenpriorisierung (IEEE 802.3)

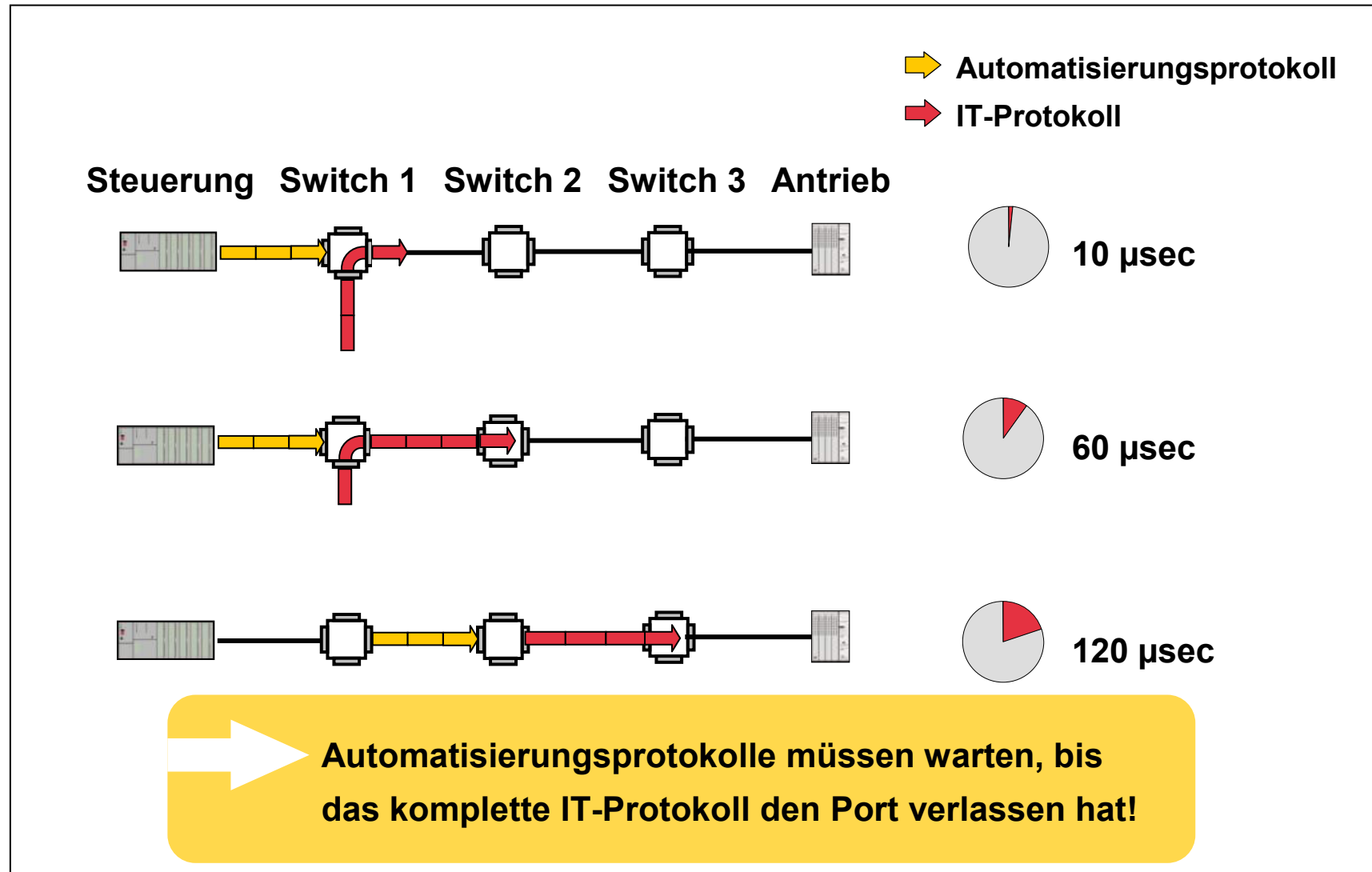

# Profile erkennen und „höher“ priorisieren

## Profinet

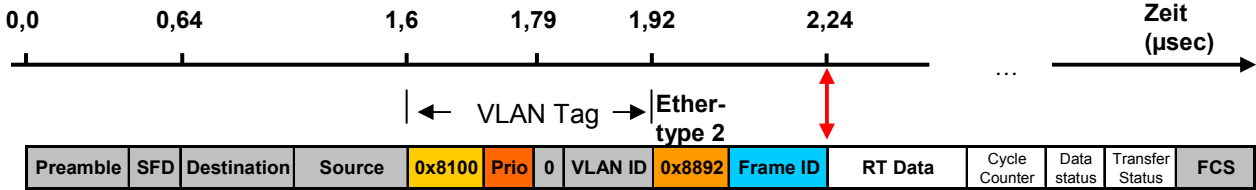

## Ethernet/IP



## Modbus TCP/IP



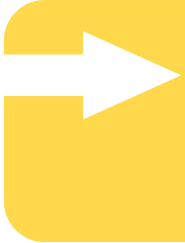

**Automatisierungsprotokolle und IT-Protokolle konkurrieren nicht mehr.  
Der Stau wird aber nicht verhindert!**

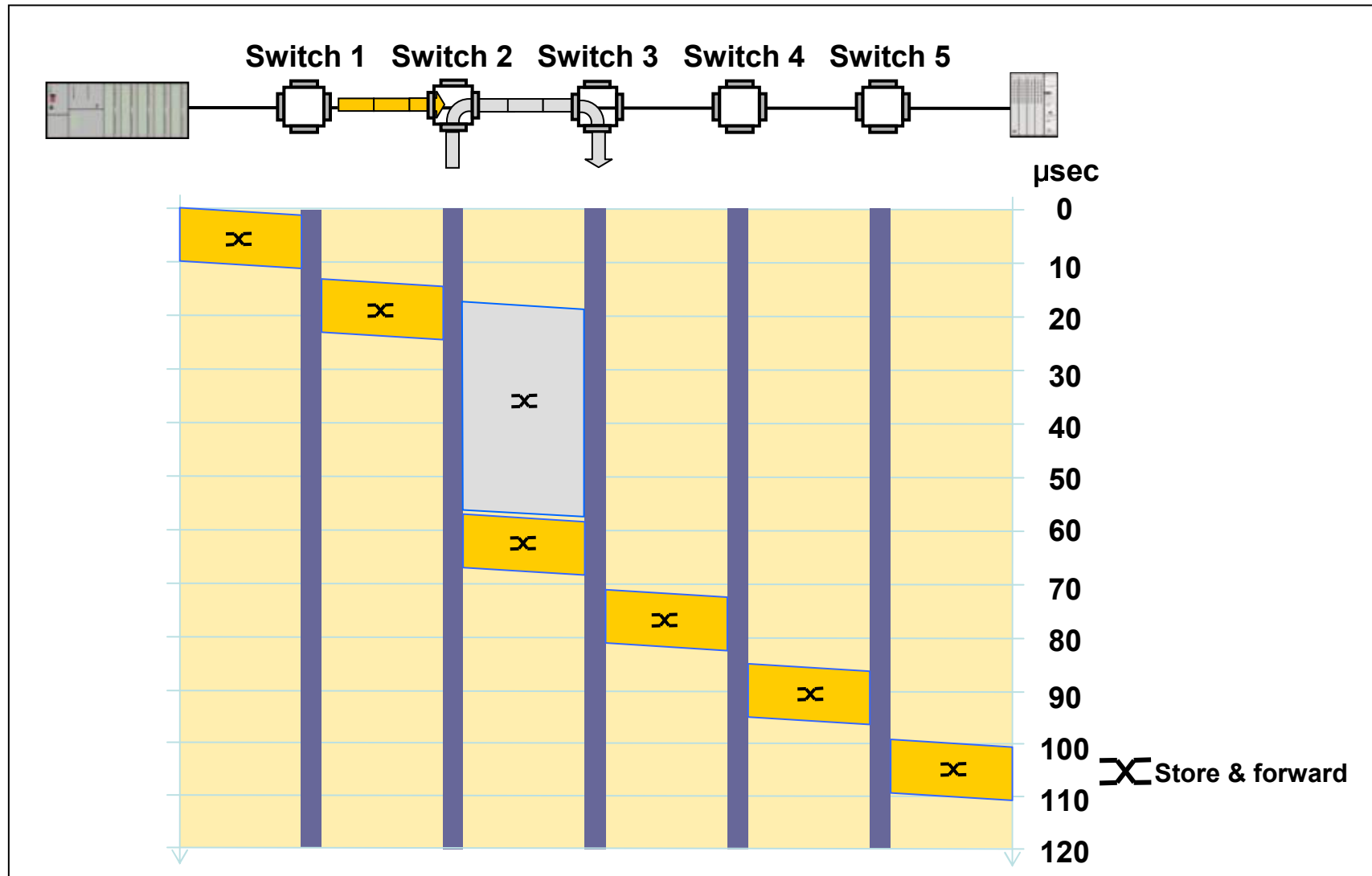
# Stau trotz Nachrichtenvorriorisierung

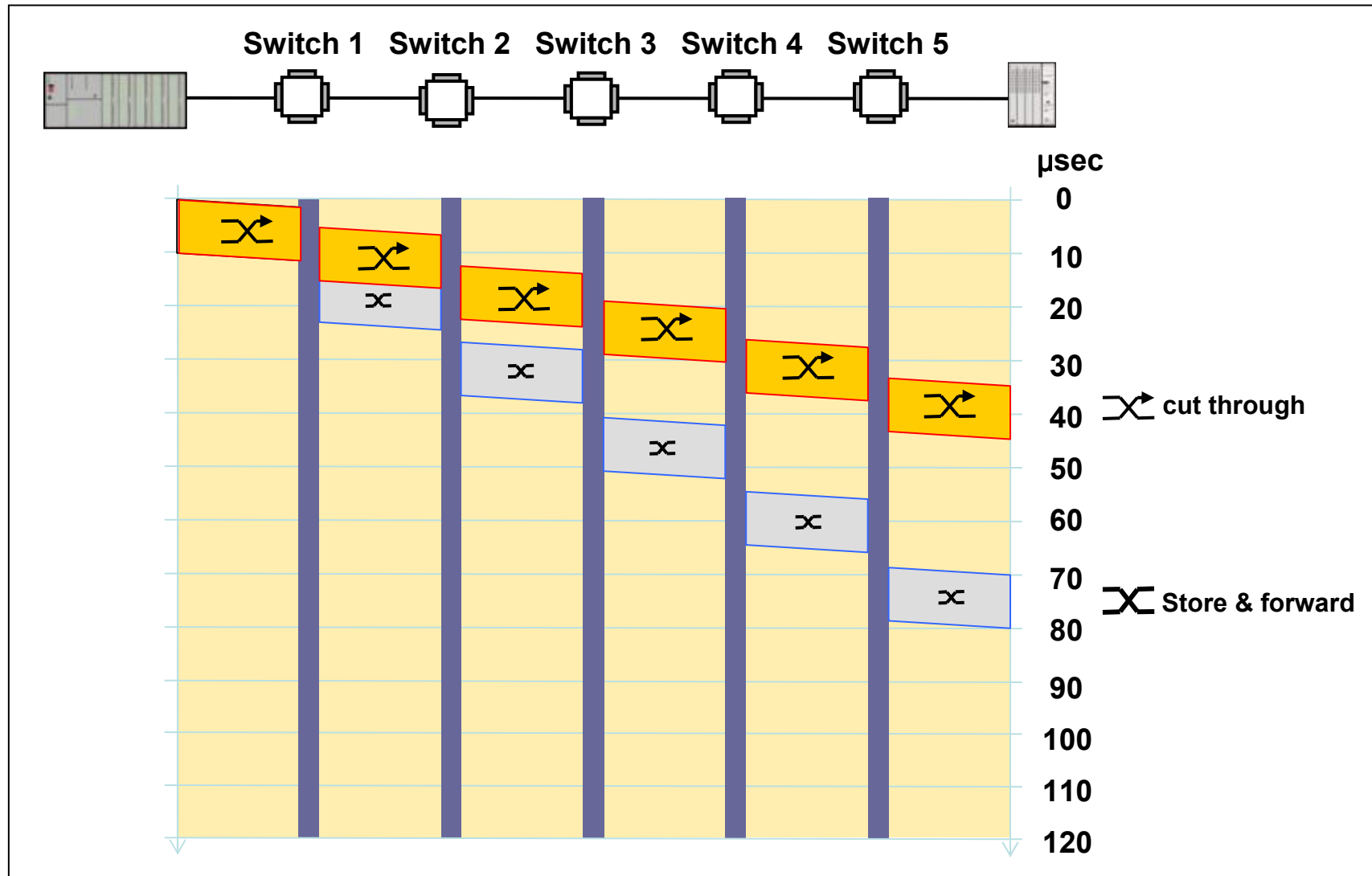

# Beschleunigung durch Cut-Through ohne Netzwerklast



# Erkannte Protokolle beschleunigen bei Netzwerklast

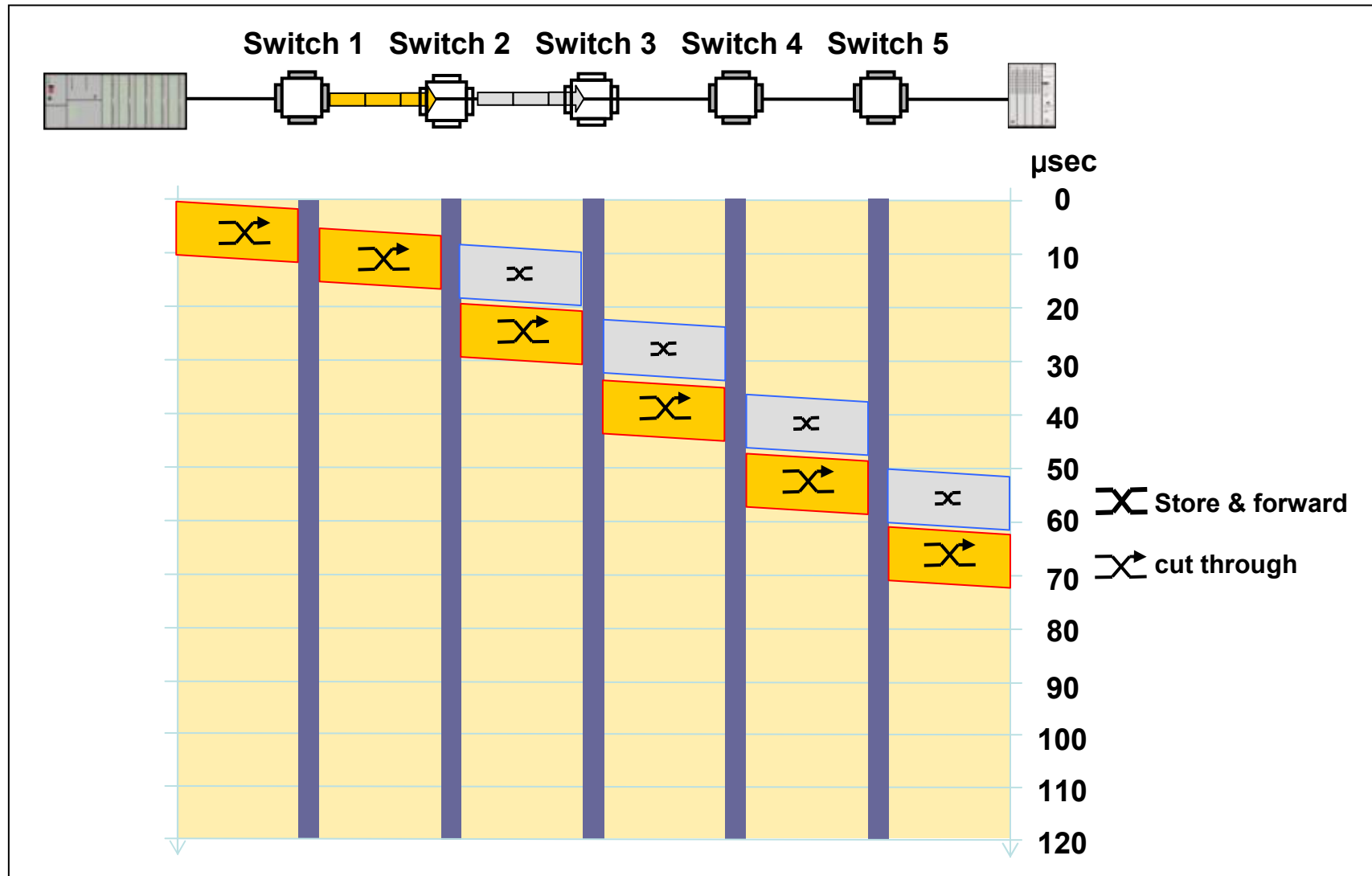

# Wie wird der Determinismus erreicht?

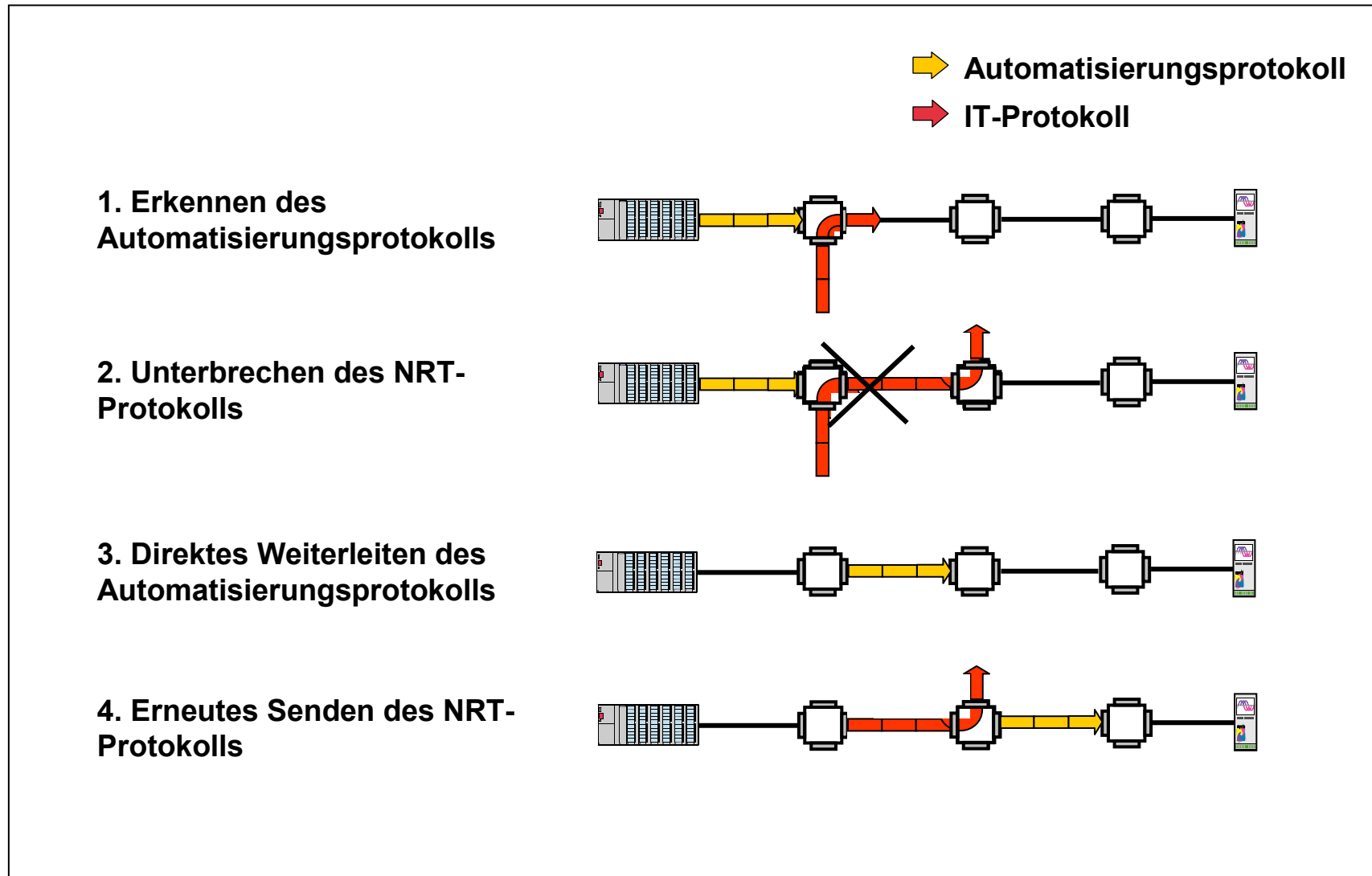

# Stau umgehen durch überholen

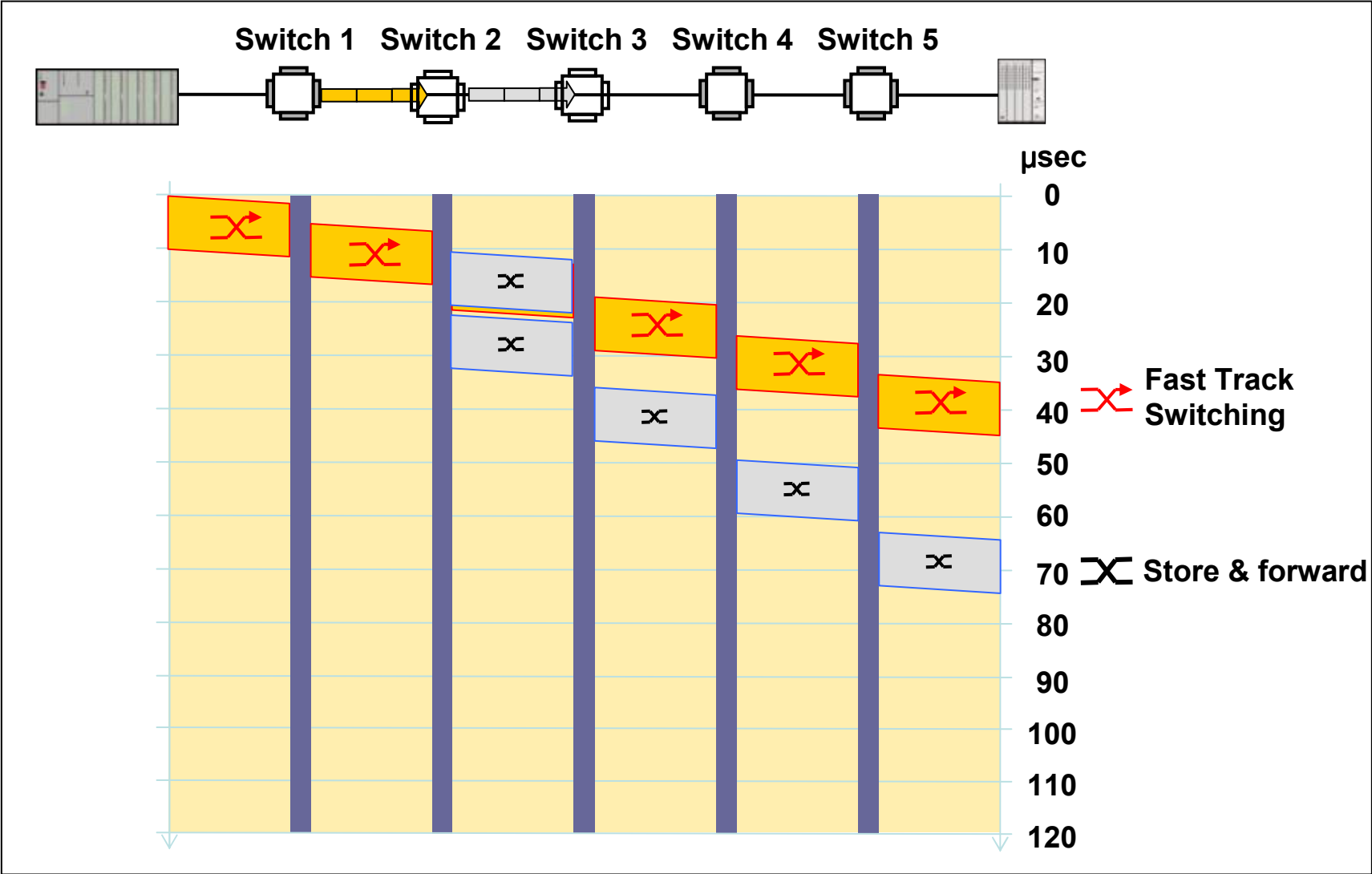

## DIE Lösung: Fast Track Switching

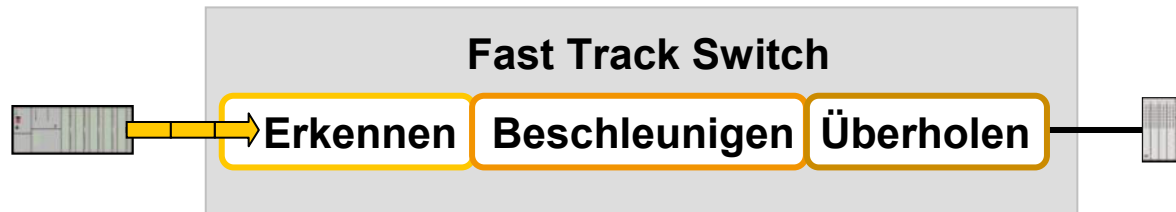

1. Erkennen des Automatisierungsprotokolls
2. Beschleunigung der Switch-Durchlaufzeit durch cut-through
3. Automatisierungsprotokolle überholen IT-Protokolle

 **Durchgängiges Ethernet bis in die Feldebene**



The logo for the Fast Track Switch is a square with a white background. It features a stylized 'X' shape formed by two overlapping lines, one yellow and one orange. Above the 'X' is the text 'Office IT' and below it is 'Industrial Automation'. The words 'Fast Track Switch' are written across the middle of the 'X'.

# Fast Track Switching - Hohe Performance und Determinismus

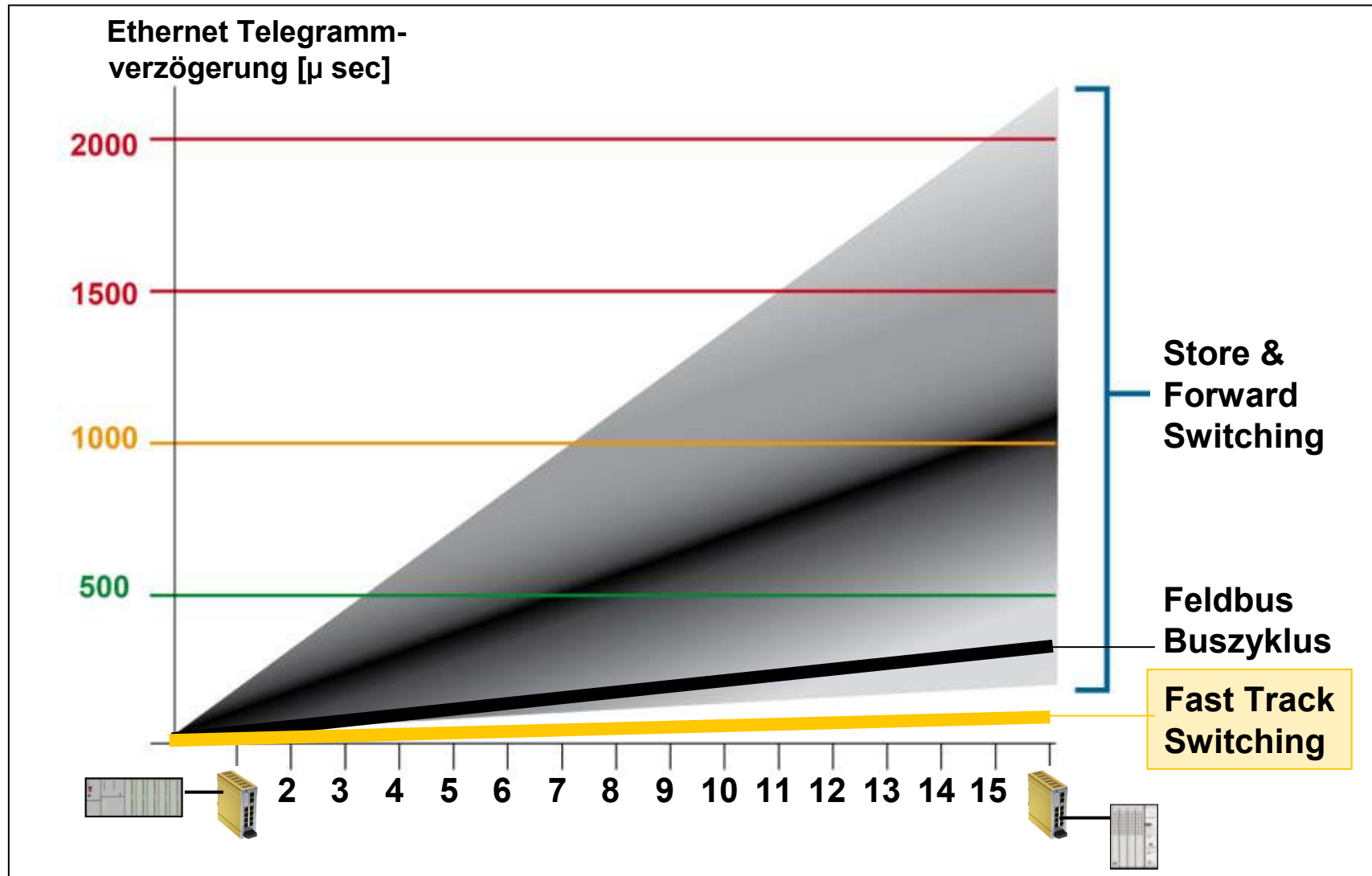

## Stärken mit Fast Track Switching für alle Ebenen

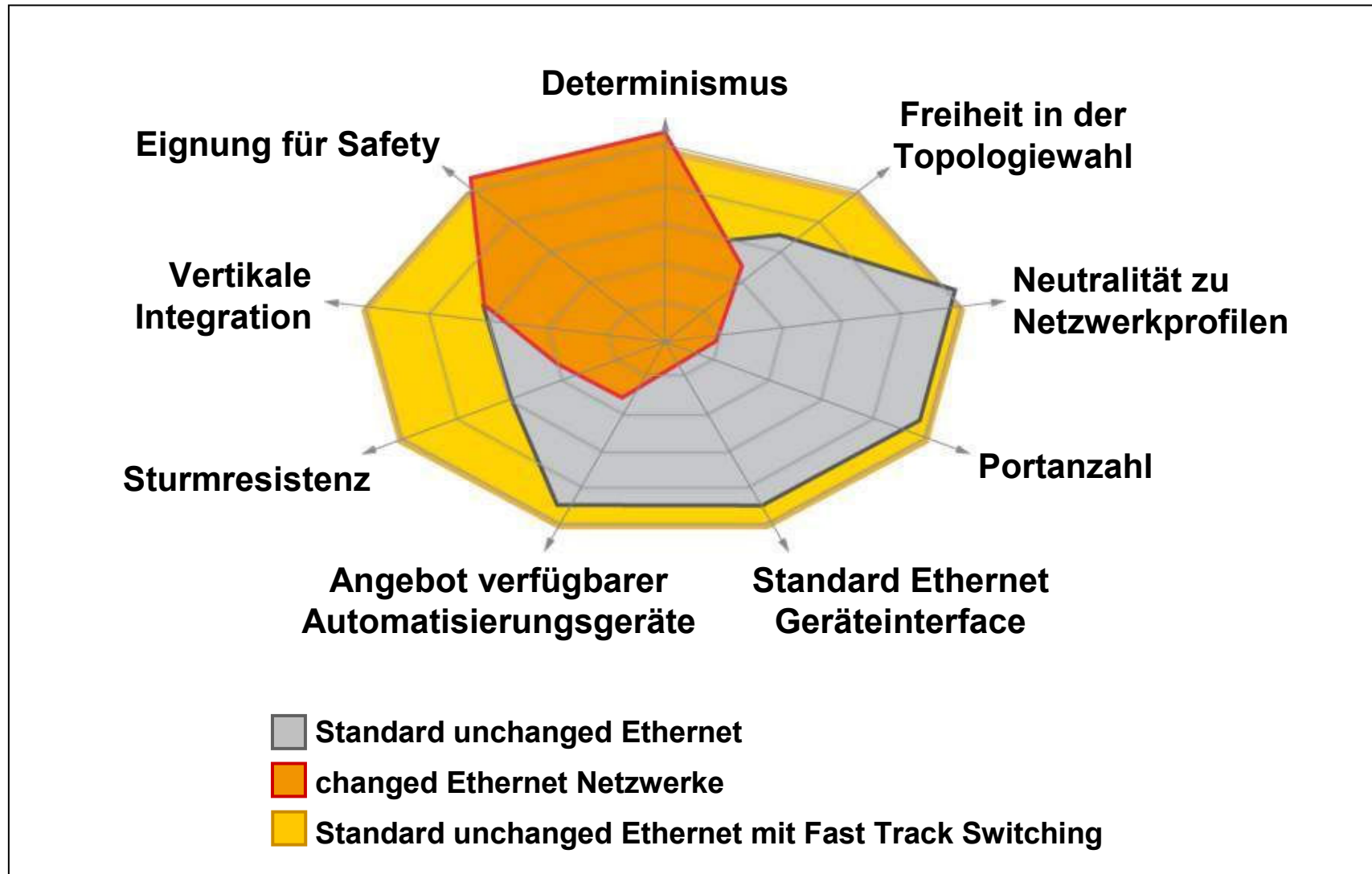

## Fast Track Switching Anwendungen

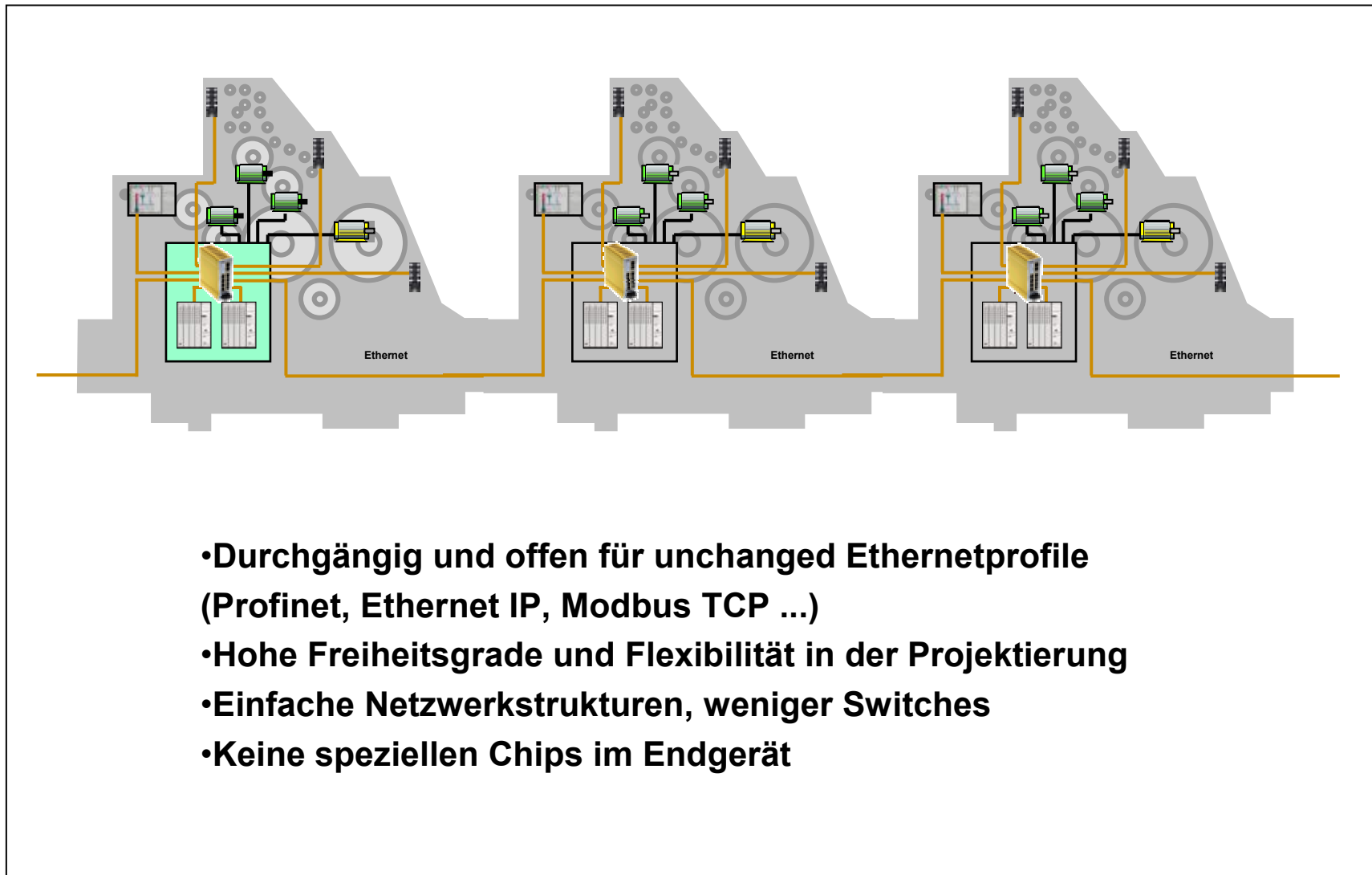

- Durchgängig und offen für unchanged Ethernetprofile (Profinet, Ethernet IP, Modbus TCP ...)
- Hohe Freiheitsgrade und Flexibilität in der Projektierung
- Einfache Netzwerkstrukturen, weniger Switches
- Keine speziellen Chips im Endgerät



## **DIE** Lösung für Automation IT

The logo for 'Fast Track Switch' features two stylized, overlapping lines that form an 'X' shape. The top-left line is yellow and the bottom-right line is orange. The text 'Fast Track Switch' is written in white, sans-serif font across the center of the 'X'.

Fast Track Switch